

ROCKO

Flooring by Kronospan



USER MANUAL #04/2023

ENGLISH VERSION



www.rocko-vinyl.com

KRONOFLOORING Sp. z o. o.
Wojska Polskiego 3
39-300 Mielec Polska
www.rocko-vinyl.com
sales.jaslo@kronospan.pl
+48 134424901

ROCKO WATERPROOF FLOORING

This document is information for the correct selection, storage, installation and usage of our product. It relates to Rocko waterproof flooring, which represents the latest generation of SPC (Stone Plastic Composite), for use in domestic and commercial areas. The core of Rocko Flooring is made with over 70% of marble, finished with a decorative layer and covered with high-quality UV varnish. Thanks to advanced production technologies, Rocko Flooring is of a very high quality and performance. Its specifications are presented in this document.



TABLE OF CONTENTS

• Compliance with construction regulations	str. 3
• Additional credentials	str. 4
• Product characteristics	str. 5
• Technical data sheet	str. 8
• Rocko Flooring range	str. 12
• Product packaging and logistic data	str. 14
• Recommended accessories	str. 16
• Installation	str. 17
• Care and Maintenance	str. 30

REQUIREMENTS



SPC flooring, installed, used and maintained in accordance with this document, meet the relevant requirements of construction regulations in force in the European Union, contained in the **Regulation of the European Parliament and of the Council (EU) No. 305/2011** of March 9, 2011, establishing harmonized conditions for the marketing of construction products..



CE marking: Rocko floor panels are CE marked in accordance with the requirements of the harmonized standard EN 14041, meeting the requirements of EU Regulation 305/2011 establishing harmonized conditions for the marketing of construction products.

Declaration of Performance according to EN 14041: Declaration of Performance has been prepared for the floor panels, in accordance with the requirements of EN 14041, meeting the requirements of EU Regulation 305/2011 establishing harmonized conditions for the marketing of construction products.



Complies with EN 16511 - Floating Floors - Multilayer semi-rigid floor covering (MMF) panels with an abrasion resistant top layer. This European Standard specifies the properties of multi-layer semi-rigid floor coverings with an abrasion resistant and decorative wear layer, supplied in panels (in the form of a tile or a board). The floor panels are considered suitable for the application in housing and public utility buildings and for floating installations.

ADDITIONAL CREDENTIALS

Kronoflooring Sp. z o. o. has an implemented and certified Quality Management System **ISO 9001: 2015** (DNV GL certificate No: 277306-2018-AQ-POL-RvA).

In **Corporate Social Responsibility (CSR)**, the company meets the requirements of the SA8000 standard by working based on the Kronospan Standard and also meets the importer's safety requirements, in accordance with with the American C-TPAT standard.



REQUIREMENTS AND CREDENTIALS BY COUNTRY



- Requirements for AqBB construction products (EN16515 for VOC and formaldehyde emissions)
- MVV TB / ABG Annex 8
- German requirements for Blue Angel RAL-UZ



- Belgian VOC requirements



- French VOC requirements



- Austrian requirements for Eco Label UZ 56



- Finnish M1 classification



- British BREEAM requirements



- American requirements of ASTM and LEED v.4
- FloorScore®
- GreenGuard Gold

ROCKO FLOORING CHARACTERISTICS



Water resistance [ISO 24336] - the product is suitable for indoor use in dry and humid conditions, such as bathroom, laundry room, kitchen or vestibule.

According to the definition, waterproof is used for a material that is fully water-resistant (waterresistant, seepage-resistant). Rocko Flooring, manufactured using SPC - Stone Plastic Composite technology, is fully waterproof, so it can be successfully used in the kitchen, bathroom or utility room.

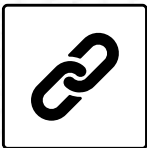

Dimensional stability [ISO 23999] - the product does not change its dimensions under the influence of temperature and humidity changes, so it can be used in sunny and shaded areas as well as in dry and humid ones.

By definition, dimensional stability is the ability of a flexible floor covering to maintain its original dimensions, when exposed to heat under certain conditions. Rocko floors guarantee dimensional stability at the level of 0.00% along the length and 0.00% along the width of the panel (according to ISO 23999 - Flexible floor coverings - Determination of dimensional stability and curling up when exposed to heat). The tests were carried out for the maximum temperature value of + 80°C.

Confirmation: EPH Certification Body - Test Certificate No. ST-19-06-11-02.



Fire resistance [EN 13501-1] - Rocko Flooring meets the requirements of Bfl-s1 class, so it is flame-retardant and has low smoke emission.

European requirements apply the Euroclass system, dividing building materials in terms of reaction to fire into classes: A1, A2, B, C, D, E, F, along with additional criteria, taking into account smoke emission. On this basis, the risk of flashover, i.e. fire spreading explosively, can be assessed. The obtained Class Bfl denotes flame-retardant floors, and the symbol s1 - low smoke emission. The classification was carried out in accordance with EN 13501-1 Fire classification of construction products and building elements - Part 1: Classification based on reaction to fire tests, and tests in accordance with EN ISO 9239-1 - Reaction to fire tests for floors - Part 1: Determination of fire performance by the radiant plate method and EN ISO 11925-2 Reaction to fire tests - Ignitability of products exposed to direct flame - Part 2: Single flame tests.

Confirmation: EPH Certification Body - Test Certificate No. BOD-19-06-11-02.

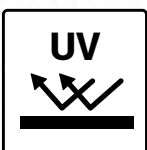

Light fastness [ISO 105-B02:2014] - due to its parameters, the product can be used in highly sunny areas. The test is performed by controlled exposure to sunlight or artificial light generated by a xenon lamp.

Resistance is assessed on two scales:

- Grayscale with a range of 1-5, where 1 is the weakest and 5 is the highest fastness to light. This is due to the difference in shade between the irradiated product and the untested product. In the normative classification, the requirement is to meet the condition > 4.
- Blue wool scale: lightfastness is awarded between 1-8. 1 - very poor, and 8 - excellent light fastness. Class 6 defines very good resistance to light, up to 100 years of normal use.

Due to the lack of dedicated standards for floor panels, the research was based on by the following standards:

- according to EN20105-B02 - Textiles. Color fastness tests. Color fast artificial light (lamp test with xenon arc decay) and
- according to EN20105-A02 Textiles - Color fastness tests - Gray scale for the assessment of color change.

The assessment was made in relation to the standard EN 13329 Laminate floor coverings - Elements with a wear layer based on aminoplastic thermosetting resins - Specifications, requirements and test methods.

Confirmation: EPH Certification Body - Test Certificate No. ST-19-06-11-04.



Abrasion resistance [EN 15468:2016] - the highest abrasion class (> 7000 cycles) guarantees long-term resistance to abrasion. The test confirms the wear resistance of the top layer.

The test is performed with the use of leather-covered wheels, under which abrasive (aluminum oxide) is sprinkled. The degree of abrasion of the surface layer is assessed after a certain number of revolutions of a tested sample. The highest normative value is defined at the level of ≥ 7000 cycles, the achieved result for Rocko Flooring exceeds this value. The test is described in the standard EN 15468 Laminate floor coverings. Elements with a direct print and a resin surface.

Specifications, requirements and test methods. The assessment of the reference values is specified in the standard EN 16511 floating floors. Multi-layer semi-rigid floor covering (MMF) panels with an abrasion-resistant top layer.

Confirmation: EPH Certification Body - Test Certificate No. ST-19-06-11-02.



Stain resistance [EN 438-2: 2019] - the top layer of Rocko floors meets the stain resistance requirements, incl. coffee, tea, alcoholic beverages or juices, cleaning agents used in kitchen, laundry, and care products used in the bathroom.

The test confirms the resistance to permanent staining. The samples are treated with many substances causing stains, to which the panels may be exposed in everyday use. Duration and contact conditions are specified for each substance. At the end of the specified exposure time, the substances are removed and the samples are tested for permanent traces on the surface. For food such as coffee, tea or milk, the test lasts 16 hours. For other substances, such as alcoholic beverages, hand cream, and chemical products such as acetic acid (30%), bleach, hair dyes, etc., an exposure time of 10 minutes is provided. Tests were performed in accordance with EN 438-2 High Pressure Decorative Laminates (HPL) - Thermosetting Resin Plates (commonly referred to as laminates) - Part 2: Determination of properties, obtaining the highest grade 5 (on a scale of 1-5), indicating no visible discoloration at the end of the test.

The requirements are specified in EN 16511 floating floors. Multi-layer semi-rigid floor covering (MMF) panels with an abrasion-resistant top layer.

Confirmation: EPH Certification Body - Test Certificate No. ST-19-06-11-02.



Underfloor heating [EN 12667] - thanks to the low thermal resistance ($0.01 \text{ m}^2 \cdot \text{K}/\text{W}$), and therefore high thermal transmittance, the panels are ideal for use with underfloor heating, both water and electric. Heat losses in this type of floor generated are at 0.4°C .

The most important factor determining the possibility of using panels for underfloor heating is the thermal resistance (R ($\text{m}^2 \cdot \text{W}/\text{K}$)). It is the ratio of the thickness of the material layer to the thermal conductivity coefficient of the material. The reciprocal of thermal resistance is the heat transfer coefficient (U), defined in the $\text{W}/\text{m}^2 \cdot \text{K}$ unit. The lower the resistance, the better. It is assumed that a thermal resistance of $0.1 \text{ m}^2 \cdot \text{K}/\text{W}$ generates a heat loss of 4°C .

The test is carried out in accordance with the EN 12667 standard. Thermal properties of building materials and products - Determination of thermal resistance by the methods of a shielded heating plate and a heat flux sensor - Products with high and medium thermal resistance. The requirements are specified in EN 14041 Flexible textile and laminate floor coverings. Essential properties.

Confirmation: EPH Certification Body - Test Certificate No. BOD-19-06-11-02



Skid resistance properties [EN 13893: 2003] - defined with DS class, confirm the dynamic friction coefficient ≥ 30 for dry and clean conditions, ensuring safe movement on the floor.

Slipping depends on the interaction of the feet (shod or bare feet) with the flooring materials. The skid resistance of a used floor depends on the type of surface and may change during its lifetime. Floor panels will normally have an acceptable skid resistance provided they are clean, dry, free of oil, grease and other slippery substances, and have been properly protected after installation and properly maintained during usage.

The value of the friction coefficient obtained by Rocko Flooring exceeds the normative requirement of ≥ 0.30 , obtaining the declared slip resistance class DS. The test was carried out according to EN 13893 Flexible, laminated and textile floor coverings - Measurement of the dynamic coefficient of friction on dry floor surfaces. The requirements are specified in the EN 14041 Flexible, textile standard and laminate floor coverings. Essential properties.

Confirmation: EPH Certification Body - Test Certificate No. BOD-19-06-11-02



Joining system [ISO 24334: 2006] - the **1cllic2go pure lock** ('fold down' type) used in Rocko Flooring ensures high-quality panel joint and at the same time easy and quick assembly with minimal use of tools. Easy to install and durable connection system thanks to the use of the 1cllic2go pure lock. A silent click ensures simple and accurate alignment of the panels to each other.

The bond strength of the panels is determined according to ISO 24334 Laminate Flooring - Determination of the locking force of mechanically installed panels.

On the short edge Rocko Flooring exceeds 5.0 kN/m, and on long edge achieves over 6.0 kN/m, thus the floor meets the requirements of EN 16511 Floating floor panels. Multi-layer semi-rigid floor covering (MMF) panels with an abrasion-resistant top layer.

Confirmation: EPH Certification Body - Test Certificate No. ST-19-06-11-02



Utility Class [ISO 10874] - due to its parameters, the product is characterized by the highest utility classes - it can be used in intensively used home conditions - e.g. corridor, hall or kitchen - class 23, as well as in commercial spaces with high traffic, such as offices or shopping centers - class 34.

In normative requirements, utility is defined by classes defined for domestic, public and light industry use. Assigning a product to a given class is conditioned by the fulfillment of technical and quality requirements specified in the subject standard. It is in the highest class, assessed on the basis of the examination of the parameters presented above in this document. These are parameters such as resistance to scratches, impacts, micro-scratches, resistance to chair wheels, table leg effect, resistance to dents, staining, lock connection strength or ensuring dimensional stability.



Rocko Flooring meets the highest requirements for the utility class in domestic applications - **class 23** and the highest class for commercial use - **class 34**. Classes beginning with a digit 2 (21, 22, 23) denote domestic use, those where the first digit is 3 (31, 32, 33, 34) are commercial use. The second number, from 1 to 4, indicates the intensity of use, i.e. at what traffic intensity a given class can be used, 1 - low intensity, and 4 the highest intensity. Rocko Flooring has the highest utility class for both domestic and public use.

Class 23 – intensive use. Examples of application areas: staircases, entrance hall, kitchen. This class ensures the resistance of the floor even in heavy traffic.

Class 34 – for intensively used rooms, intensive use. Examples of application areas: corridor, office, large-scale department stores, classrooms, hotel facilities.

Requirements for the classes are indicated in the standard EN 16511 Floating floor panels. Multilayer semi-rigid floor covering (MMF) panels with an abrasion-resistant top layer.

Confirmation: EPH Certification Body - Test Certificate No. ST-19-06-11-02

TECHNICAL DATASHEET

Rocko - 6 mm (5+1 mm)

Flooring for floating installation, Level of use according to EN 16511: Class 34



For intensively used living areas

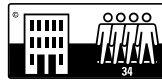

For flooring subject to intensive use in commercial premises



DIMENSIONS

	thickness	5,0 mm	
dimensions	Integrated Underlay	1,0 mm	
	length	1210 mm	
	width	192-295 mm	
profile	long side	1 clic 2go pure	short side 1 clic 2go pure
groove	long side		short side

TOLERANCE

squareness	EN 16511	≤ 0,20 mm
straightness	EN 16511	≤ 0,30 mm / m
flatness crosswise	EN 16511	concave: ≤ 0,15% · convex: ≤ 0,20%
flatness lengthwise	EN 16511	concave: ≤ 0,50% · convex: ≤ 1,00%
openings between elements	EN 16511	average: ≤ 0,15 mm · max: ≤ 0,20 mm
height difference between elements	EN 16511	average: ≤ 0,10 mm · max: ≤ 0,15 mm

TEST

abrasion resistance method B	EN 16511	≥ 7000 cycles
impact resistance	EN 16511	≥ 1800 mm
micro scratch resistance	EN 16511	≤ MSR-A2
stain resistance	group 1 & 2	grade 5
	group 3	grade 5
castor chair test	EN 16511	no change in appearance after 25.000 cycles
effect of furniture leg	EN 16511	no visible damage
thickness swelling	EN 16511	no swelling
residual indentation	EN 16511	≤ 0,15mm
light fastness	EN 20105-B02	blue wool scale 6
	EN 20105-A02	grey scale ≥ 4
locking strength	EN 16511	long side ≥ 2,0 kN/m
		short side ≥ 3,5 kN/m
dimensional stability	EN 16511	≤ 0,25 %

ENVIRONMENT

emission of formaldehyde	EN 717-1	class E1, formaldehyde free, no emission
--------------------------	----------	--

PHYSICAL BEHAVIOR

fire behaviour	EN 13501-1	Bfl-s1
slide resistance	EN 13893	DS
thermal resistance	EN 12667	0,025 (m²K)/W
thermal conductivity	EN 12667	0,23 W/(m*K)
walking noise reduction	IHD-W-431	38%
impact sound reduction	EN ISO 10140-3	16 dB

The data sheet is updated regularly to meet new technological standards.
This version replaces all previous versions as well as those which are undated.
This version takes effect upon creation. Version 01/2023

kronospan

Kronoflooring Sp. z o.o.,
38-200 Jasto, ul. Przemysłowa 10, Poland

Flooring for floating installation, Level of use according to EN 16511: Class 34



For intensively used living areas



For flooring subject to intensive use in commercial premises



DIMENSIONS

	thickness	5,0 mm · tmax - tmin ≤ 0,50 mm	
dimensions	length	1210 mm · lmax - lmin ≤ 0,50 mm	
	width	295 ± 0,10 mm · wmax - wmin ≤ 0,20 mm	
profile	long side	1 clic 2go pure	short side 1 clic 2go pure
	groove	long side	short side

TOLERANCE

squareness	EN 16511	≤ 0,20 mm
straightness	EN 16511	≤ 0,30 mm / m
flatness crosswise	EN 16511	concave: ≤ 0,15% · convex: ≤ 0,20%
flatness lengthwise	EN 16511	concave: ≤ 0,50% · convex: ≤ 1,00%
openings between elements	EN 16511	average: ≤ 0,15 mm · max: ≤ 0,20 mm
height difference between elements	EN 16511	average: ≤ 0,10 mm · max: ≤ 0,15 mm

TEST

abrasion resistance method B	EN 16511	≥ 7000 cycles
impact resistance	EN 16511	≥ 1800 mm
micro scratch resistance	EN 16511	≤ MSR-A2
stain resistance	group 1 & 2	grade 5
	group 3	grade 5
castor chair test	EN 16511	no change in appearance after 25.000 cycles
effect of furniture leg	EN 16511	no visible damage
thickness swelling	EN 16511	no swelling
residual indentation	EN 16511	≤ 0,15mm
light fastness	EN 20105-B02	blue wool scale 6
	EN 20105-A02	grey scale ≥ 4
locking strength	EN 16511	long side ≥ 2,0 kN/m
		short side ≥ 3,5 kN/m
dimensional stability	EN 16511	≤ 0,25 %

ENVIRONMENT

emission of formaldehyde	EN 717-1	class E1, formaldehyde free, no emission
--------------------------	----------	--

PHYSICAL BEHAVIOR

fire behaviour	EN 13501-1	Bfl-s1
slide resistance	EN 13893	DS
thermal resistance	EN 12667	0,01 (m ² K)/W
thermal conductivity	EN 12667	0,437 W/(m*K)
walking noise reduction	IHD-W-431	37%
impact sound reduction	EN ISO 10140-3	6 dB

The data sheet is updated regularly to meet new technological standards.
This version replaces all previous versions as well as those which are undated.
This version takes effect upon creation. Version 01/2019

kronospan

Kronoflooring Sp. z o.o.,
38-200 Jasto, ul. Przemysłowa 10, Poland

Flooring for floating installation, Level of use according to EN 16511: Class 34



For intensively used living areas

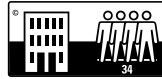

For flooring subject to intensive use in commercial premises

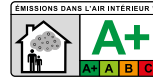

DIMENSIONS			
dimensions	thickness	5,0 mm · tmax - tmin ≤ 0,50 mm	
	length	1210 mm · lmax - lmin ≤ 0,50 mm	
	width	234 ± 0,10 mm · wmax - wmin ≤ 0,20 mm	
profile	long side	1 clic 2go pure	short side 1 clic 2go pure
groove	long side		short side

TOLERANCE		
squareness	EN 16511	≤ 0,20 mm
straightness	EN 16511	≤ 0,30 mm / m
flatness crosswise	EN 16511	concave: ≤ 0,15% · convex: ≤ 0,20%
flatness lengthwise	EN 16511	concave: ≤ 0,50% · convex: ≤ 1,00%
openings between elements	EN 16511	average: ≤ 0,15 mm · max: ≤ 0,20 mm
height difference between elements	EN 16511	average: ≤ 0,10 mm · max: ≤ 0,15 mm

TEST		
abrasion resistance method B	EN 16511	≥ 7000 cycles
impact resistance	EN 16511	≥ 1800 mm
micro scratch resistance	EN 16511	≤ MSR-A2
stain resistance	group 1 & 2	grade 5
	group 3	grade 5
castor chair test	EN 16511	no change in appearance after 25.000 cycles
effect of furniture leg	EN 16511	no visible damage
thickness swelling	EN 16511	no swelling
residual indentation	EN 16511	≤ 0,15mm
light fastness	EN 20105-B02	blue wool scale 6
	EN 20105-A02	grey scale ≥ 4
locking strength	EN 16511	long side ≥ 2,0 kN/m
		short side ≥ 3,5 kN/m
dimensional stability	EN 16511	≤ 0,25 %

ENVIRONMENT		
emission of formaldehyde	EN 717-1	class E1, formaldehyde free, no emission

PHYSICAL BEHAVIOR		
fire behaviour	EN 13501-1	Bfl-s1
slide resistance	EN 13893	DS
thermal resistance	EN 12667	0,01 (m ² k)/W
thermal conductivity	EN 12667	0,437 W/(m*K)
walking noise reduction	IHD-W-431	37%
impact sound reduction	EN ISO 10140-3	6 dB

The data sheet is updated regularly to meet new technological standards.
This version replaces all previous versions as well as those which are undated.
This version takes effect upon creation. Version 01/2019

Flooring for floating installation, Level of use according to EN 16511: Class 34



For intensively used living areas

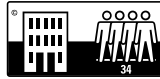

For flooring subject to intensive use in commercial premises

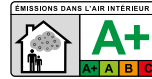

DIMENSIONS			
dimensions	thickness	5,0 mm · tmax - tmin ≤ 0,50 mm	
	length	1210 mm · lmax - lmin ≤ 0,50 mm	
	width	192 ± 0,10 mm · wmax - wmin ≤ 0,20 mm	
profile	long side	1 clic 2go pure	short side 1 clic 2go pure
groove	long side		short side

TOLERANCE		
squareness	EN 16511	≤ 0,20 mm
straightness	EN 16511	≤ 0,30 mm / m
flatness crosswise	EN 16511	concave: ≤ 0,15% · convex: ≤ 0,20%
flatness lengthwise	EN 16511	concave: ≤ 0,50% · convex: ≤ 1,00%
openings between elements	EN 16511	average: ≤ 0,15 mm · max: ≤ 0,20 mm
height difference between elements	EN 16511	average: ≤ 0,10 mm · max: ≤ 0,15 mm

TEST		
abrasion resistance method B	EN 16511	≥ 7000 cycles
impact resistance	EN 16511	≥ 1800 mm
micro scratch resistance	EN 16511	≤ MSR-A2
stain resistance	group 1 & 2	grade 5
	group 3	grade 5
castor chair test	EN 16511	no change in appearance after 25.000 cycles
effect of furniture leg	EN 16511	no visible damage
thickness swelling	EN 16511	no swelling
residual indentation	EN 16511	≤ 0,15mm
light fastness	EN 20105-B02	blue wool scale 6
	EN 20105-A02	grey scale ≥ 4
locking strength	EN 16511	long side ≥ 2,0 kN/m
		short side ≥ 3,5 kN/m
dimensional stability	EN 16511	≤ 0,25 %

ENVIRONMENT		
emission of formaldehyde	EN 717-1	class E1, formaldehyde free, no emission

























PHYSICAL BEHAVIOR		
fire behaviour	EN 13501-1	Bfl-s1
slide resistance	EN 13893	DS
thermal resistance	EN 12667	0,01 (m²K)/W
thermal conductivity	EN 12667	0,437 W/(m*K)
walking noise reduction	IHD-W-431	37%
impact sound reduction	EN ISO 10140-3	6 dB

The data sheet is updated regularly to meet new technological standards.
This version replaces all previous versions as well as those which are undated.
This version takes effect upon creation. Version 01/2019

kronospan

Kronoflooring Sp. z o.o.,
38-200 Jasto, ul. Przemysłowa 10, Poland

ROCKO FLOORING RANGE

Collection	Thickness	Utilization class	Residential Guarantee*	Locking System	V-Groove	Waterproof	Floor heating	Sound Insulation	Slide resistant	SKU's Total
1210 x 192	5+1 mm	34						PerfectPad®		8
1210 x 295	5 mm	34						-		9
1210 x 234	5 mm	34						-		4
1210 x 192	5 mm	34						-		11

*The guarantee is valid for domestic use acc. to the conditions of guarantee (detailed terms of guarantee: www.rocko-vinyl.com)

1210 x 192 x 5+1 mm PerfectPad®

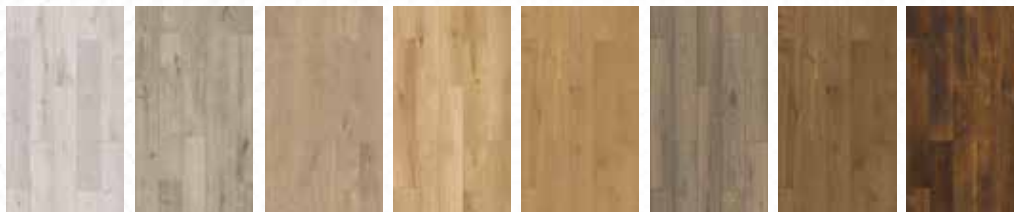

R078 Airflow, HS
R077 Barista, HS
R065 Rope, HS
R073 Scandipure, HS
R081 Crescendo, HS
R076 Bourbon Cask, SO
R082 Humidor, SO
R070 Incando, SO

1210 x 295 x 5 mm

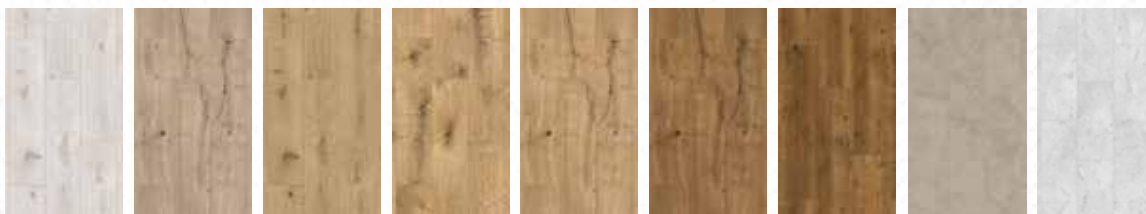

R129 White Poppy, SO
R125 Mornel, SO
R128 Ascot, SO
R126 Bashmore, SO
R123 Nutmeg, SO
R124 Clove, SO
R149 Brown Marten, SO
K538 Dovetail Arosa, PT
R109 Concrete, PT

1210 x 234 x 5 mm

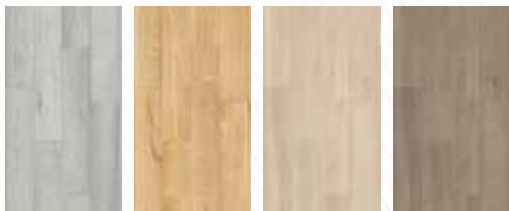

R063 Alkemi, HS
R066 Sculpta, HS
R148 Clamshell, SO
R150 Brenton, SO

1210 x 192 x 5 mm

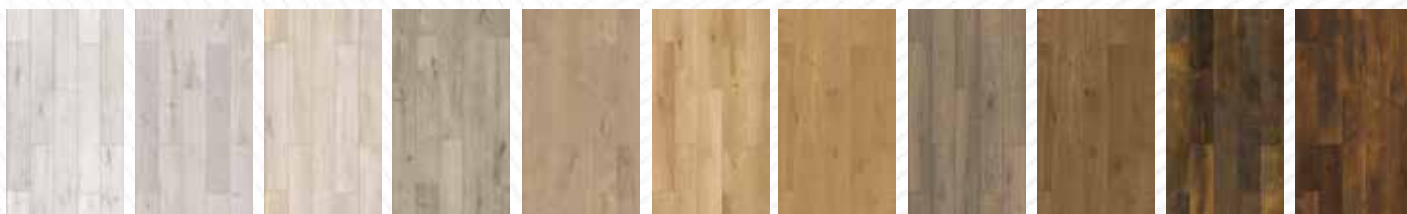

R079 Salt Mine, SO
R078 Airflow, HS
R071 Crystal Shore, SO
R077 Barista, HS
R065 Rope, HS
R073 Scandipure, HS
R081 Crescendo, HS
R076 Bourbon Cask, SO
R082 Humidor, SO
R090 Castlebridge, SO
R070 Incando, SO

PRODUCT PACKAGING AND LOGISTIC DATA

Rocko panels are delivered in cardboard boxes. Each one includes a product label with legally required markings, installation and maintenance instructions and warranty conditions.

Each panel has a batch and production identification code printed on the bottom. Panels are delivered according to with the following table:

RANGE	pc/box	m ² /box	box/pal	m ² /pal	kg/pal	pal/truck	m ² /truck	pal/con. 20 ['] *	m ² /con. 20 ['] *
1210 x 192 x 5 + 1 mm	7	1,63	72	117,09	1179	20	2342	17	1991
1210 x 295 x 5 mm	6	2,14	45	96,38	940	25	2409	22	2120
1210 x 234 x 5 mm	7	1,98	48	95,14	924	25	2378	22	2093
1210 x 192 x 5 mm	8	1,86	52	96,65	945	25	2416	22	2126

* EU

Packaging

Rocko Flooring is packed in a 6-sided cardboard box with markings and installation instructions on the bottom of each pack.

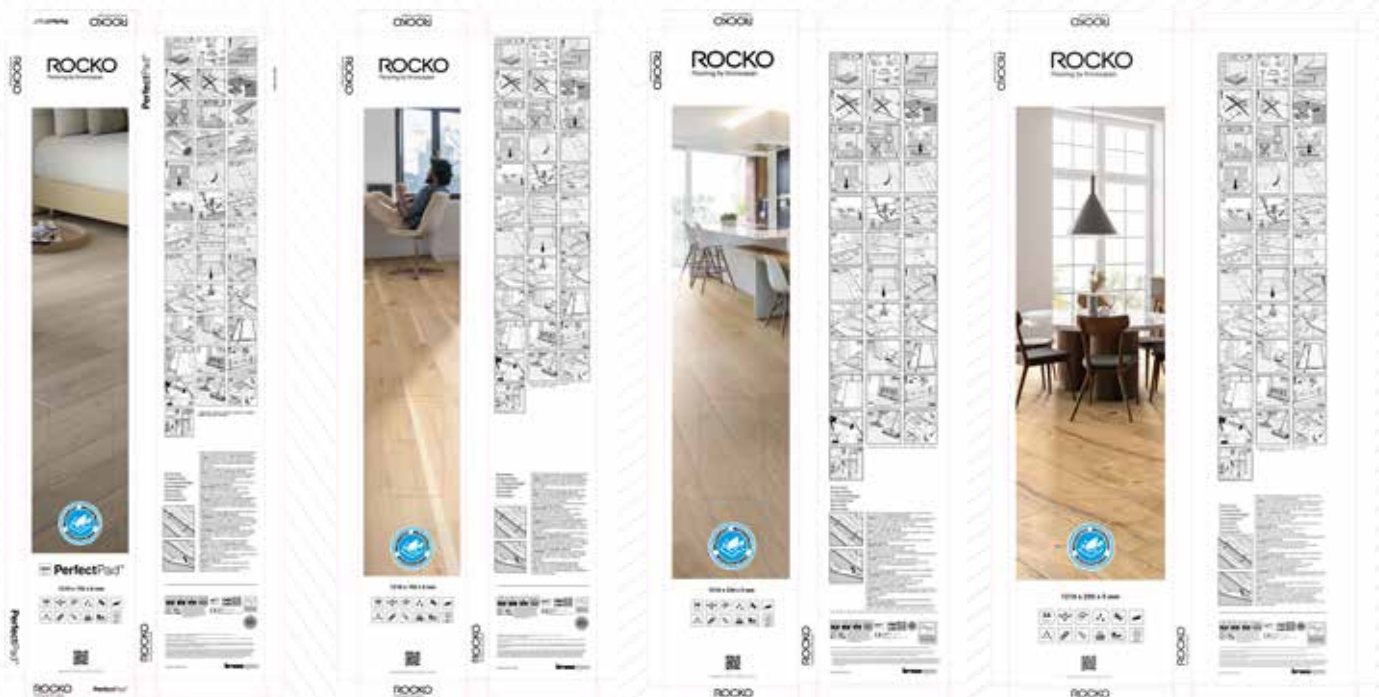

Label

Each box contains a product label with the name and decor code, EAN code and packing details. The label is placed on short side of the box.



Bulk packaging

Rocko Flooring boxes are packed on wooden pallets, secured with foil and PET tapes, marked with inclusive label.



Shipping scheme

Truck 24t



Shipping scheme

Container 20'

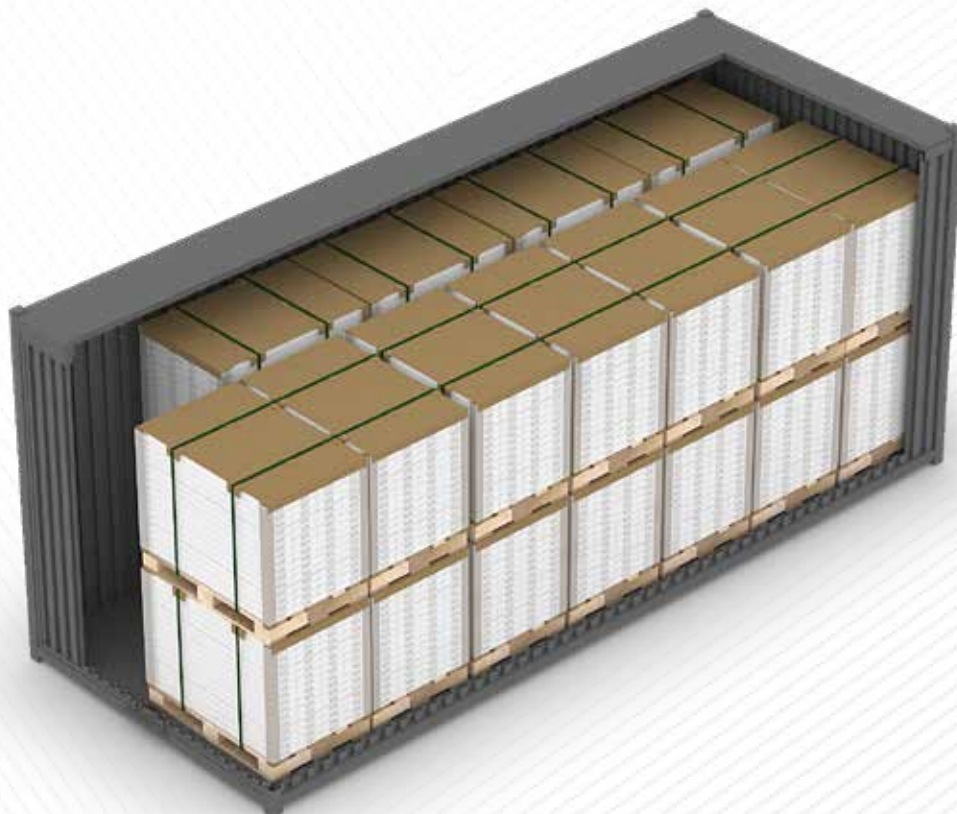

RECOMMENDED ACCESSORIES

Rocko waterproof skirting boards

Rocko skirting boards (2400 x 18 x 58) are resistant to moisture and impact and are color and pattern matched to Rocko Flooring decors. Mounted using mounting clamps or glues, no additional finishing accessories are needed. The skirting boards can be cut at an angle.



Rocko PUR 1.0 acoustic underlay

Durable acoustic underlay with a 1 mm thickness, intended for floating floors, including SPC floors, with very high performance parameters (static load CS> 530 kPa; dynamic load DL>3.000.000 cycles; thermal resistance 0.01 m²K / W). Packed in 10x1m rolls.



PE vapor barrier foil, 0.20 mm thick

High-strength polyethylene foil should not be less than 200 microns (0.2 mm) thick. Only then is it able to be an effective obstacle to moisture.



Tapping block

Tapping block 168/90x70x20mm, enabling accurate and smooth installation of SPC floor.



Rocko cleaning agent

Active SPC floor cleaning and care agent that removes dirt and greasy deposits. It does not damage the surface and does not leave a gray film on surface.



ROCKO FLOORING INSTALLATION

OVERAGE ALLOWANCES	Order 10% more flooring than square footage to account for cuttings and waste
INSTALLATION ON STAIRS OR VERTICAL SURFACES	Voids Warranty
INSTALLATION OVER EXISTING CERAMIC TILE FLOORS	Filling grout lines required (follow subfloor flatness tolerances)
GLUE DOWN INSTALLATION	Voids Warranty
EXPANSION GAP REQUIREMENTS	10mm around perimeter walls and heavy fixed objects and on area over 400 m ²
REQUIRED INTERIOR ENVIRONMENTAL CONDITIONS	15°C - 30°C [59°F - 86°F] MOISTURE 40-60%, acclimation requirements 48h.

Tools for installation

- Utility knife
- Straight edge, measuring tape, pencil
- Spacers
- Tapping block
- Soft-faced hammer
- Broom or vacuum cleaner
- Felt or nylon pads
- Vapor barrier foil PE min. 0,2 mm
- **Optional:** jigsaw, table saw, miter saw, circular saw, hole saw., Panels underlay max 1 mm, Cs min. 530 kPa.



JOB SITE EVALUATION

Prior to installation, the homeowner or installer must ensure that the job site conditions (incl. subfloor/ substrate, ambient temperature and relative humidity) will not negatively affect the floor. The manufacturer is not responsible for damages associated with improper installation or poor site conditions.

MOISTURE

Test all concrete subfloors for moisture content and document the results. Visual checks are not reliable. Moisture still must be checked even though Rocko Flooring is waterproof in order to protect surrounding structure.

Perform tests at locations around exterior doorways, near walls containing plumbing, near foundations walls and the center of the room.

GENERAL SUBFLOOR REQUIREMENTS

- Must be level to within max. 2mm in 1m [0,08" in a 40"] span. No bumps or low spots.
- Must be clean; no construction debris, soil, mud or any other objects on or adhering to the floor; if necessary, scrape and sweep away before the installation; no protrusions of nails, debris or metals should remain.
- Must be free from moisture-related conditions that can damage the installed flooring.
- Before laying the floor, the subfloor must be secured PE vapor barrier foil, min. 0.2 mm.
- Be structurally sound without deflection.

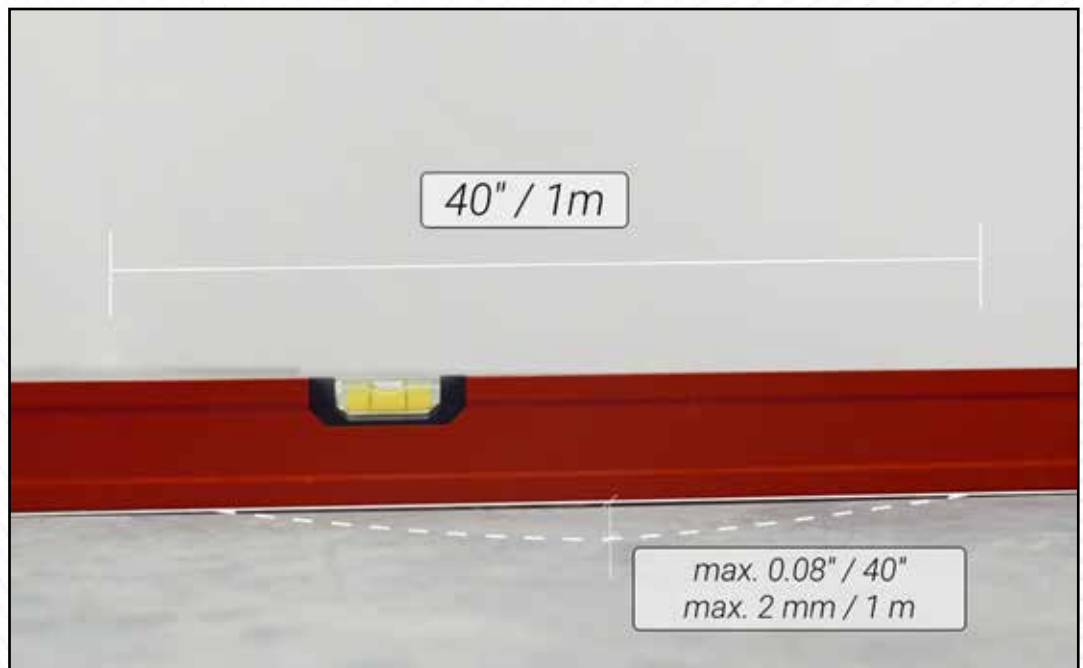
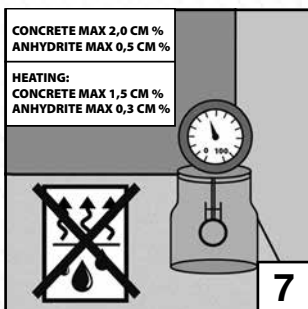
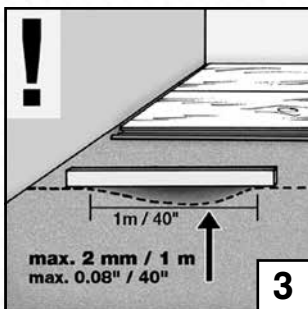

APPROVED SUBFLOORS:

Concrete, Plywood, OSB, Particleboard, Tile (Ceramic, Terazzo, Stone).

CONCRETE SUBFLOORS

- High spots can be removed by grinding; depressions can be filled with patching compound formulated for use in floor installation
- Cure for at least 90 days (applies for newly-laid concrete slabs).
- the maximum permissible humidity is 2% CM and 1.5% CM for underfloor heating

WOOD (PLYWOOD, OSB, PARTICLEBOARD, CHIPBOARD, SOLID HARDWOOD, PARQUET)

- Existing floors must be firmly attached to the structural floor
- Perform moisture tests using a reliable moisture meter in multiple locations. Moisture readings should never exceed 14% for plywood, OSB, particleboard, chipboard and solid wood subfloors.
- If moisture readings exceed 14%, it should be corrected at the job site before installing [insert brand] vinyl plank flooring.

TILE, TERRAZZO, STONE

- Existing floors must be firmly attached to the structural floor.
- Fill in grout lines on ceramic tiles, terrazzo, stone and similar floors with a cementitious leveling and patching compound.

ANHYDRITE FLOORS (GYPSUM)

- protrusions can be removed by grinding; the cavities can be filled with the appropriate one putty compound intended for the floor.
- the floor must be hardened for at least 90 days.
- the maximum permissible humidity is 0.5% CM and 0.3% CM for underfloor heating.

Rocko Flooring can be installed directly on a vapor barrier foil or foil and acoustic underlay.

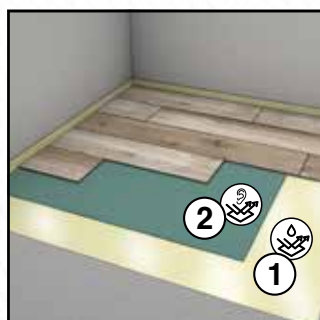
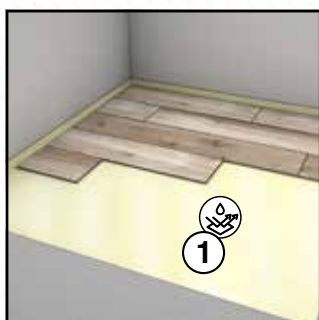

1. PE vapor barrier foil min. 0.2 mm
2. Underlay for panels max. 1 mm, CS min. 530 kPa

NON-APPROVED SUBFLOORS:

Carpeting/carpet pads, floating floors (all types), cushioned vinyl flooring (sheet vinyl), laminate, cork, rubber, underlays with CS<530 kPa, DL<3.000.000 cycles; max. 1mm thickness.

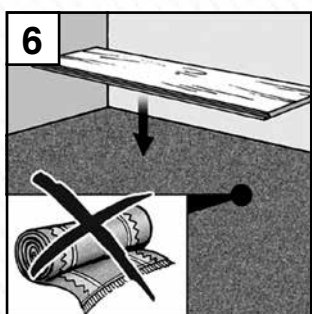

Remove floors listed above and remove old adhesives before installing Rocko Flooring.

IN-FLOOR RADIANT HEAT

- This floor can be installed over radiant heat concrete subfloors
- Electric and hydro systems are acceptable
- In-floor radiant components must be a minimum of 40 mm [1/57 "] below flooring
- Floor surface temperature should never exceed 27° C [81° F]
- Heating system should be operational at least two weeks prior to installation to calibrate temperature settings
- Flooring cannot be laid directly over radiant heating mats
- **Before laying the floor, the subfloor must be secured PE vapor barrier foil, min. 0.2 mm.**

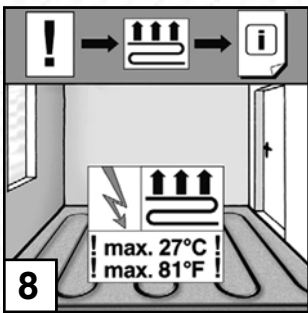

Rocko Flooring can be installed directly on a vapor barrier foil or foil and acoustic backing.

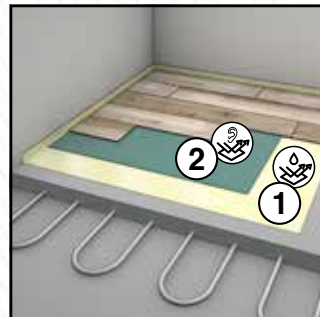
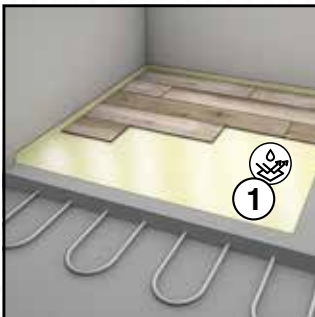

1. PE vapor barrier foil min. 0.2 mm
2. Underlay for panels max. 1 mm, CS min. 530 kPa

INSTALLATION

1.

The installation of Rocko plank flooring does not generally require acclimation in residential applications if the product is stored properly. If the product is subject to extreme hot or cold temperatures prior installation, allow the product to acclimate to room temperature. The room of installation must be between 15°C - 30°C [59°F - 86°F]. Product should be stored horizontally in dry area in controlled environmental conditions (eg. garages, external patios are not acceptable to store flooring).



Required temperature 15°C - 30°C [59°F - 86°F]
Acclimation: **Required room moisture 40-60%,**
time of acclimation 48h.

2.

Before starting the installation, measure the length and width of the room. Properly planned arrangement of the panels prevents from having very short panels in rows and narrow panel widths at the walls. Remember to keep the minimum board length of 400 mm.

3.

Measure the length of the room. Divide it by the length of the planks. If the resulting number is less than 400mm (16"), you will need to cut your first plank accordingly to avoid having planks that are less than 400mm (16") on the opposite end of the room.

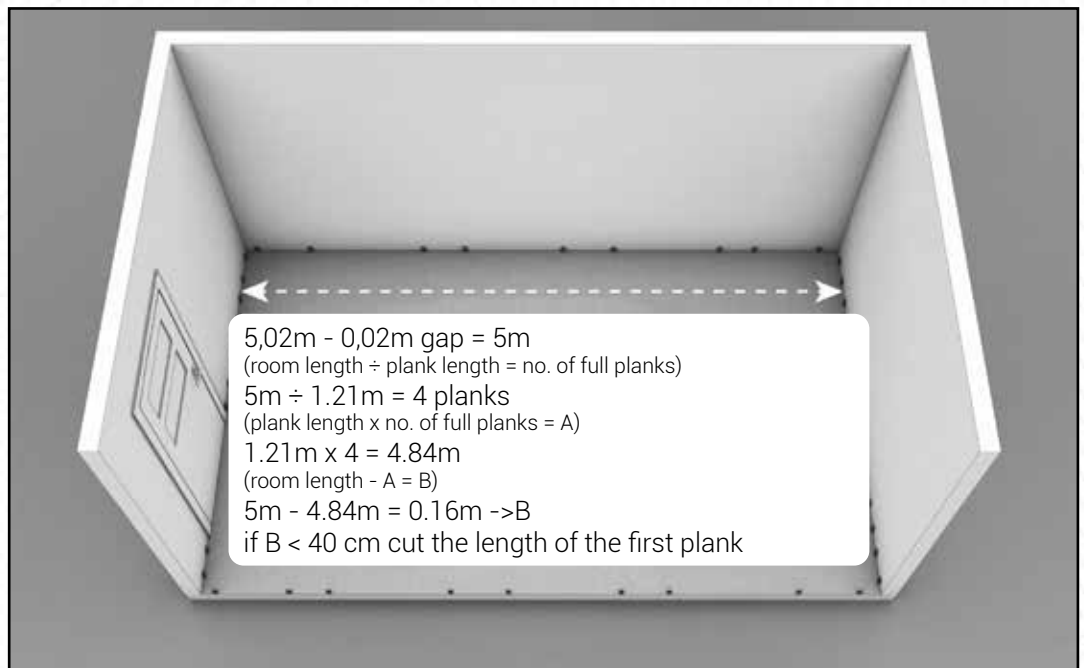

4.

Calculate the width of the last row - measure the width of the room and divide it by the width of the plank. If the number is less than half of the width of the plank, then you need to trim first and the last row to avoid too narrow planks.

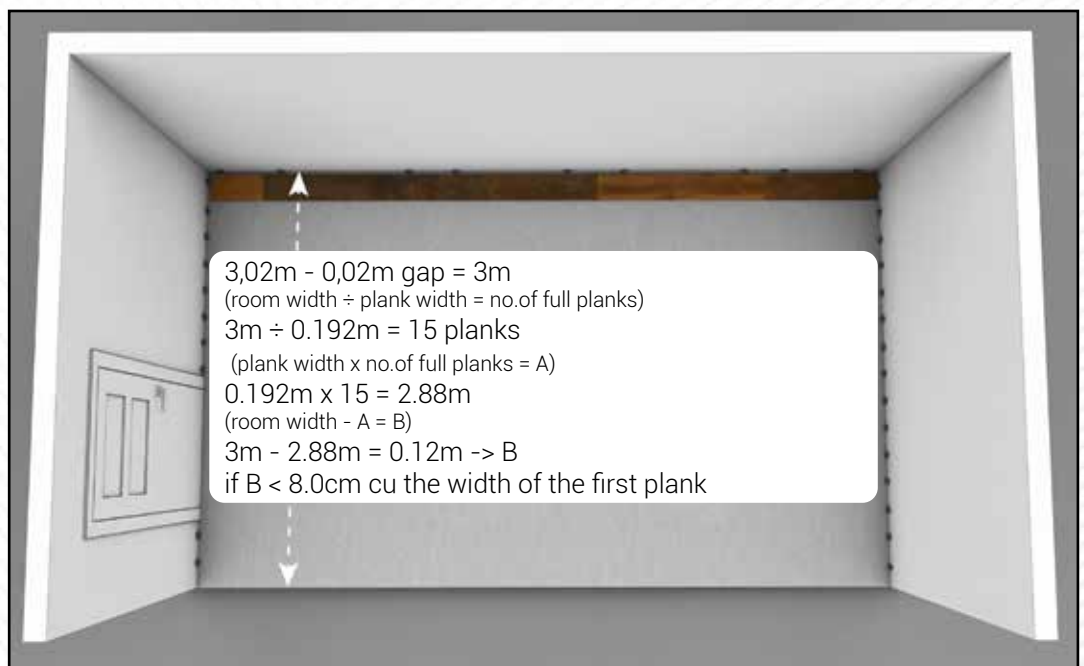

5. VERY IMPORTANT!

Protect the substrate against moisture. Use a PE vapor barrier foil with a thickness of 0.20 mm, then glue the joints with a vapor barrier foil and fold it over the walls to a height of 20 mm. For panels without pre-attached pad, an additional acoustic underlay can be used, however, it must meet the following parameters:

- maximum thickness 1.0mm
- minimum compressive strength CS 530kPA

We recommend using a dedicated **PUR1.0** polyurethane underlay available from our distributors.

Features of PUR 1.0 underlay

- recommended for SPC vinyl floors,
- suitable for underfloor heating,
- recommended for rooms with high traffic,
- minimizes the risk of breaking the locks during use.

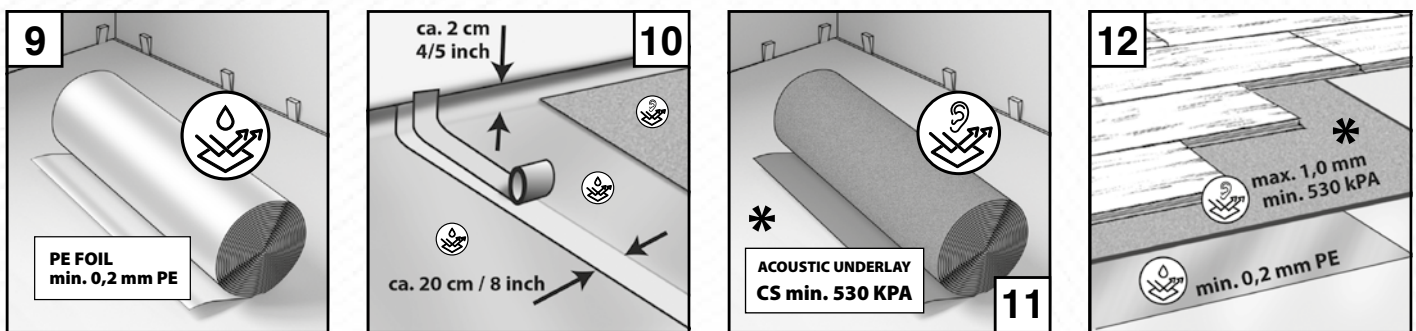

5A ROCKO FLOORING WITH PERFECT PAD INSTALLATION

Installation conditions are as in Rocko Flooring without pre-attached pad. The difference is the lack of additional underlayment application – there must be no separate underlayment used.

Installation Rocko Flooring with PerfectPad®

Installation Rocko Flooring



5B GLUE DOWN INSTALLATION

It is allowed to glue down Rocko Flooring. NOTICE! Applies only Rocko Flooring without pre-attached Perfect Pad.

One should use poliuretane, R2 type adhesive. Subsurface must be prepared according to adhesive producer application requirements (seasoning, leveling, moisture content).



- 6.** Set spacers to allow a minimum gap of 10mm (0,4") around the perimeter of the subfloor for movement of product expansion. Do not remove the spacers until the installation is complete. The expansion gaps should be covered by skirting boards.



- 7.** Start the installation by placing supporting planks by the wall, keeping the extension gap. You should place one supporting plank per each short seam of first row. Supporting planks will be removed in further installation steps.

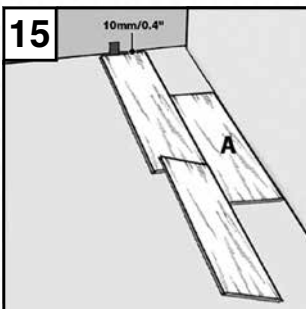

8.

Start the installation at the left hand corner and proceed with the tongue facing the wall. When starting your first row, lock the two first planks in place by folding down second piece, then tap down on the top of the planks on the short seams using tapping block and a hammer.



9.

To cut the end plank in first row, simply mark the proper measurement and score the plank using utility knife and a straightedge, then just snap the plank along the score line. You will also need to back cut the underlayment on the bottom of the plank. You can use excess cut pieces to start rows, if they're at least 40cm (16-in).

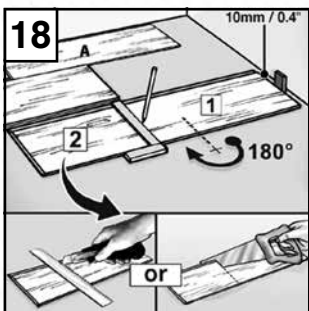

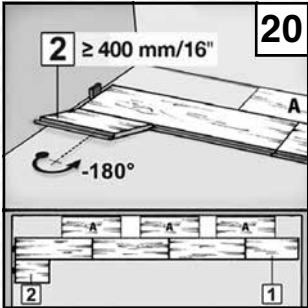

Cut off piece > 40cm | 16"

10.

When installing second row, connect the long site of the plank first, then slide the plank so the short sites meet. Then drop it lock the short ends. Use a tapping block and a hammer to ensure proper fit on short seams. Continue laying planks as you go until the row is complete.

11.

Remove the supporting planks and slide connected panels against the wall.

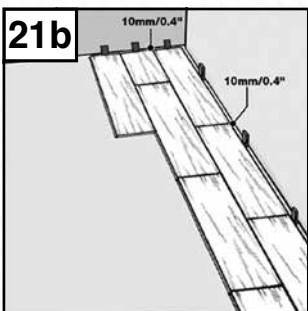
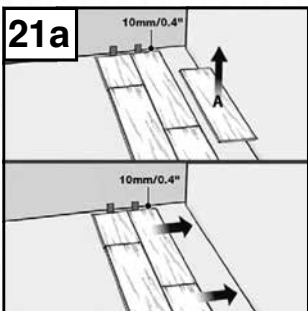

12.

Continue the installation staggering the joints at least 40cm (16-in) and maintaining the extension gap - the staggered seams pattern can be repeated each row, or be random.



13.

Cover the extension gaps by the Rocko skirting boards, installed at the end of the project.



14.

Fill any expansion spaces around potentially wet areas with premium waterproof 100% silicone caulk.

15.

Remember, the use of transition profiles is required when installing Rocko in a room or area that is larger than 20x20 meters (65 lineal feet) in any direction, so that the floor is separated into sections that are no longer than 20x20 meters (65 ft. x 65 ft.) per section.

16.

Save and protect any leftover planks. They can be used for replacement in the event you need to replace a plank in the future.

Installation Rocko Flooring with PerfectPad®



More information:



www.rocko-vinyl.com

Installation Rocko Flooring

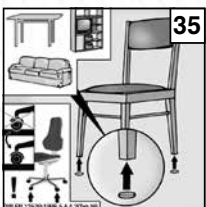
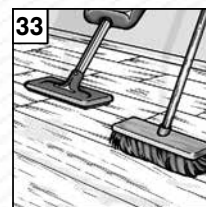
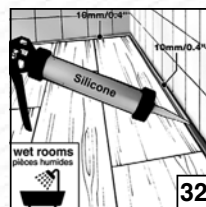
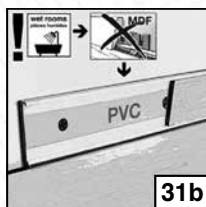
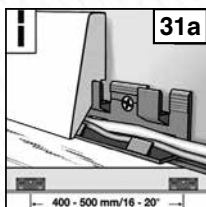
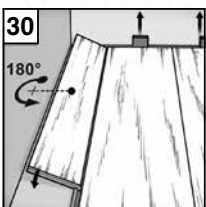
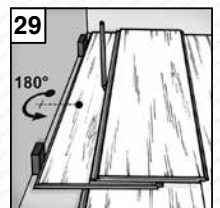
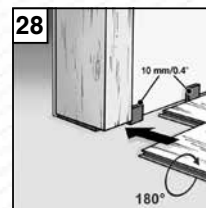
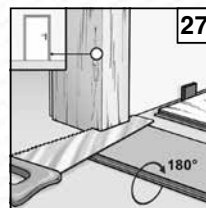
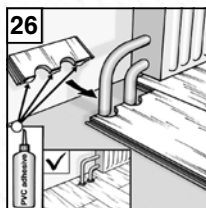
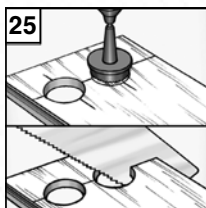
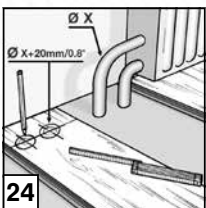
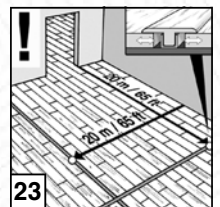
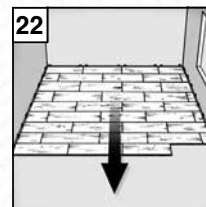
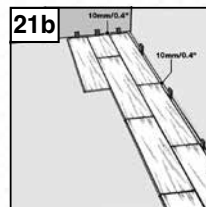
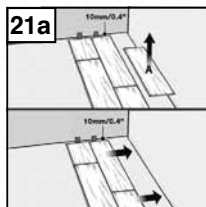
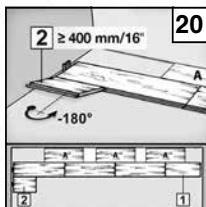
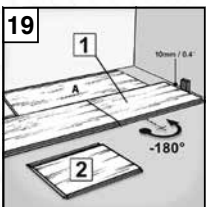
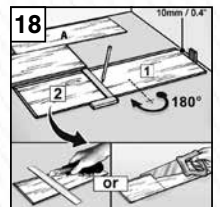
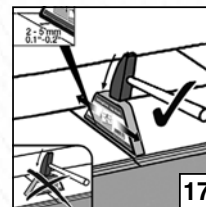
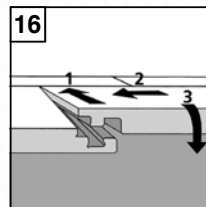
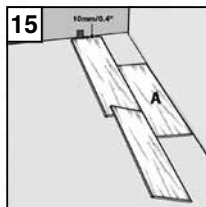
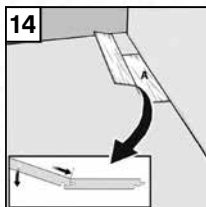
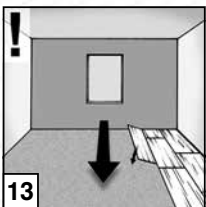
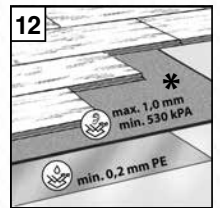
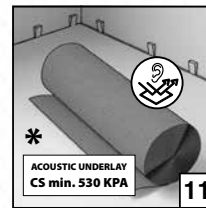
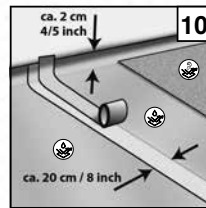
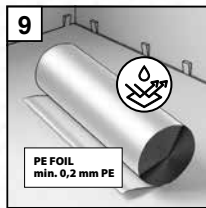
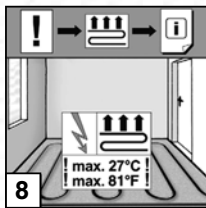
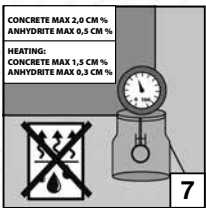
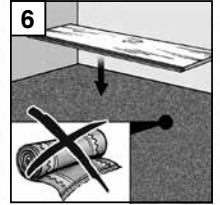
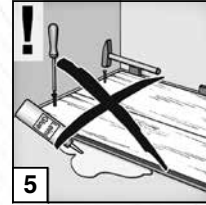
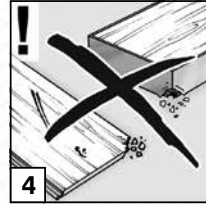
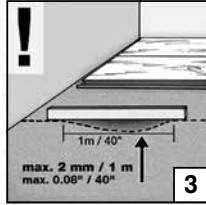

More information:



www.rocko-vinyl.com

CARE AND MAINTENANCE

CLEANING UP AFTER ASSEMBLY

Rocko Flooring can be used immediately after installation. Remove any loose post-assembly components and dirt with a broom or vacuum cleaner, then wash the floor. The vacuum cleaner (with soft wheels) should be equipped with a brush tip, to avoid scratching the floor. To clean the floor, use a suitable cleaning agent diluted in lukewarm water. Change the water until the water is clear and the floor is free of dirt and dust.

DAILY CARE AND CLEANING

Dirt should be removed with a broom or a vacuum cleaner with a suitable tip. The floor should be regularly washed using the Rocko cleaning and care agent, diluted in lukewarm water according to the manufacturer's instructions. Wash the floor with a damp, not too fluffy mop (preferably made of microfiber). Do not use wire or nylon sponges as they can damage the floor surface.

Use only Rocko care and cleaning agents, as other aggressive cleaning agents can damage the surface. Do not use detergents based on soap, waxes or rinse aid, as they can stick to the surface and leave unsightly streaks difficult to remove. Do not use abrasive cleaners or bleaches as they may scratch or dull the surface of the floor.

Rocko Flooring can be cleaned with a steam cleaner. The floor must not come into direct contact with water vapor - make sure that the steam cleaner is equipped with a suitable textile cover with not too fluffy bristles. The cover will ensure a uniform distribution of water vapor and temperature. Do not leave the steam cleaner in one place for a long period of time.

SECURING FURNITURE

Furniture legs should be secured with appropriate protective pads, and castor chairs should be equipped with soft castors. Moving heavy furniture and objects across the floor is forbidden.

FLOOR PROTECTION

Doormats should be placed at the front door to prevent dirt and sand from being brought in and thus reduce the risk of damaging the floor.

ROCKO

Flooring by Kronospan



www.rocko-vinyl.com

04/2023/EN

Product information in this brochure is correct at time of publication. The company has a policy of continuous product development and reserves the right to change any product specifications given in this brochure. Due to the variations in the printing process, colours in this brochure may be subject to deviation from the actual products.

kronospan

Distributor:

Kronoflooring Sp. z o.o.

Producer: 39-300 Mielec
Kronoflooring Sp. z o.o. ul. Wojska Polskiego 3
38-200 Jasło T +48 17 58 22 200
ul. Przemysłowa 10 F +48 17 58 22 300
T +48 13 44 24 901 sales.jaslo@kronospan.pl